



**LIFETIME
WARRANTY**

Lek

Full Extension Concealed

DTC Undermount SLIDES with Locking Device

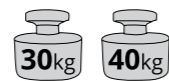

LIFETIME WARRANTY

FEATURES & SPECIFICATIONS

Full Extension
 Tool free assembly and removal of drawer
 Silent system guarantees smooth run without noise
Finish: Zinc Plated
Length: 300-600mm
Drawer up & down adjustment: 0-+3mm
Maximum drawer side thickness: 16mm
Depths (mm): 300, 350, 400, 450, 500, 550, 600

Planning

NL - Nominal Slide Length
 LT - Internal Cabinet Depth $LT=NL+3$

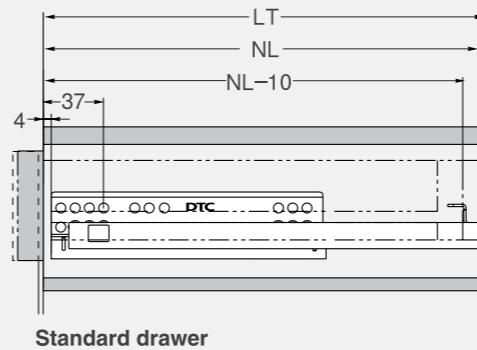

Standard drawer

NL - Nominal Slide Length
 LT - Internal Cabinet Depth $LT=NL+21$

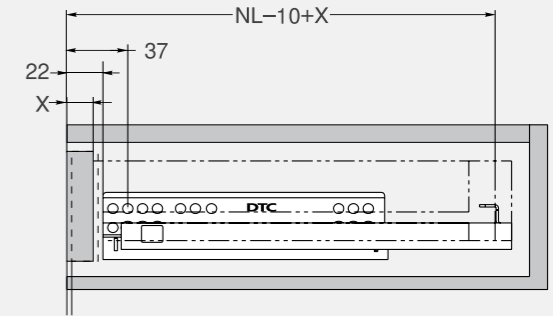

Inner drawer

1 Slides (Left/Right)

10 Sets/
CTN

Pre-zinc Steel

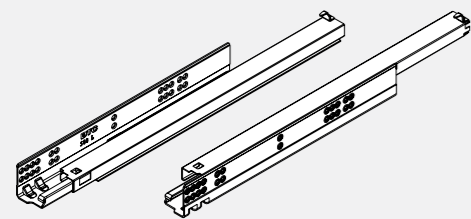

NL, mm	30kg	40kg
300	SSC09-300KG30	-
350	SSC09-350KG30	-
400	SSC09-400KG30	-
450	SSC09-450KG30	-
500	SSC09-500KG30	SSC09-500KG40
550	-	SSC09-550KG40
600	-	SSC09-600KG40

Space Requirement

NL: Nominal Length

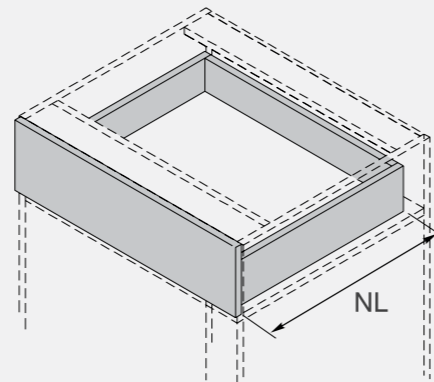

Soft Close Drawer

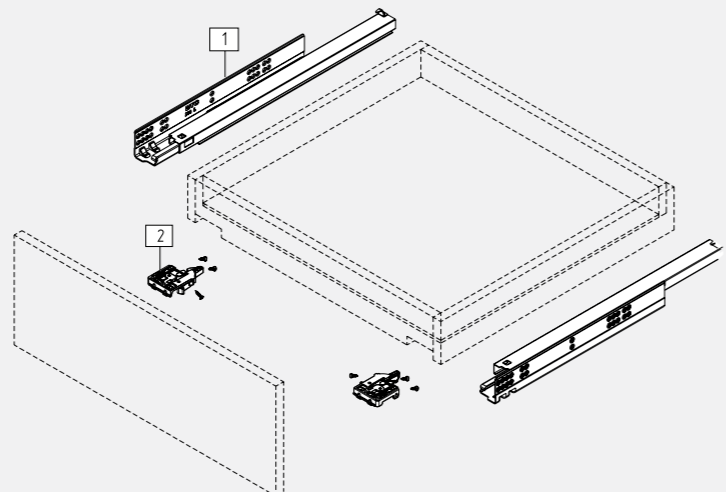

2 Locking device (L/R)

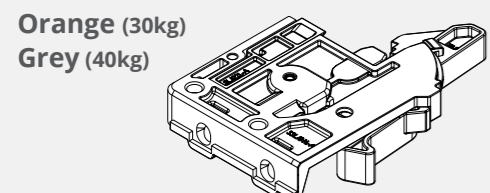

Screw Positions of the Slides (mm)

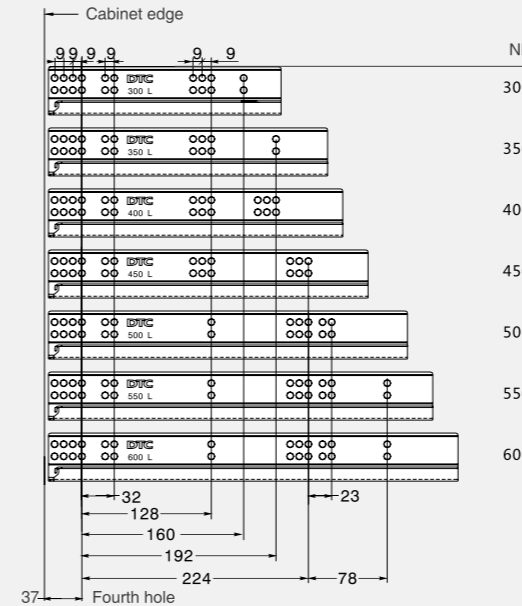

Fixing hole position for inner drawer

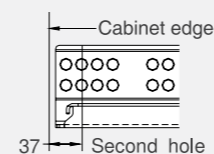

Installation Dimensions (mm)

SKW - Internal Drawer Width
 LW - Internal Cabinet Width

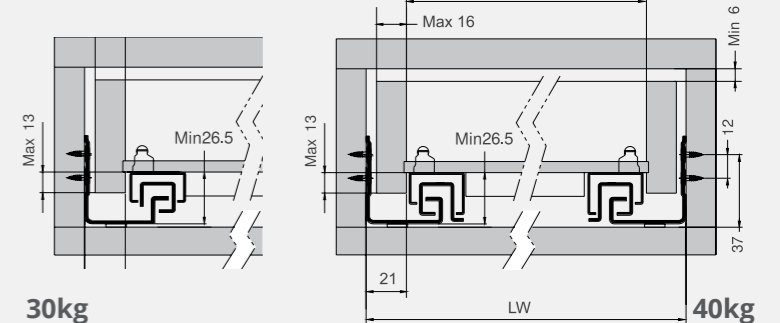

Drawer Back Preparation (mm)

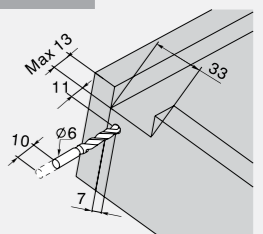

Locking Device Installation (mm)

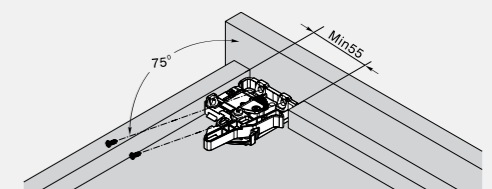

ASSEMBLY & ADJUSTMENT

Drawer Assembly with Locking Device

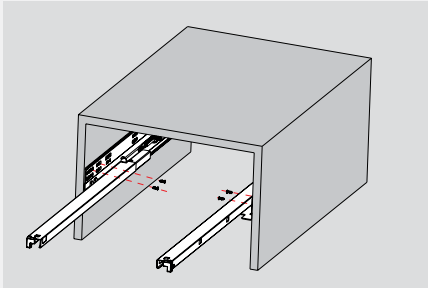

Fix the slide onto the cabinet

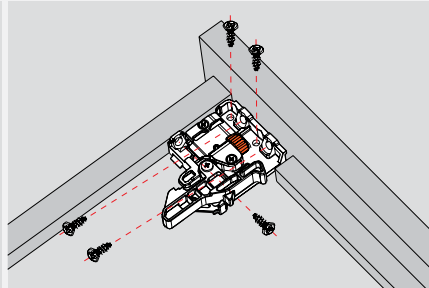

Fix the locking device onto the drawer bottom

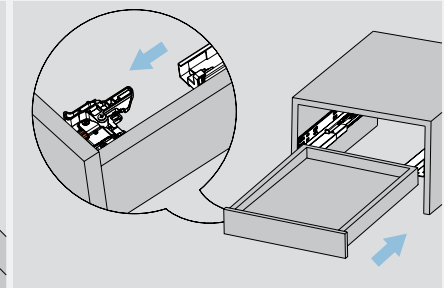

Lay the drawer bottom onto the slide then push the drawer into the cabinet

Removal with Locking Device

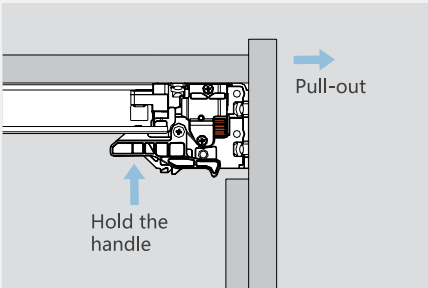

For removal, hold the handle and pull out the drawer

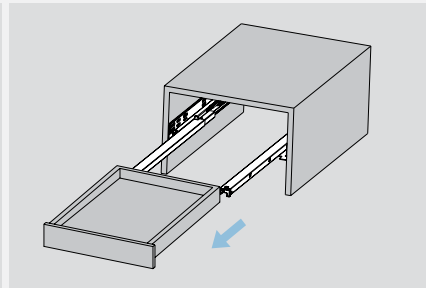

Lek

Phone: 1300 489 399
Email: info@leksupply.com.au
Website: www.leksupply.com.au

VIC Head Office
37-41 Letcon Drive
Bangholme (Dandenong South),
VIC 3175

NSW
188 Newton Road,
Wetherill Park, NSW 2164

QLD
36 Smallwood Street,
Underwood, QLD 4119

SA
41 Weaver Street,
Edwardstown, SA 5039